

**DRACO D19 SL**

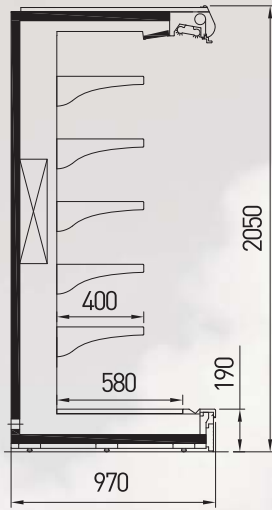

**DRACO M19 SL**

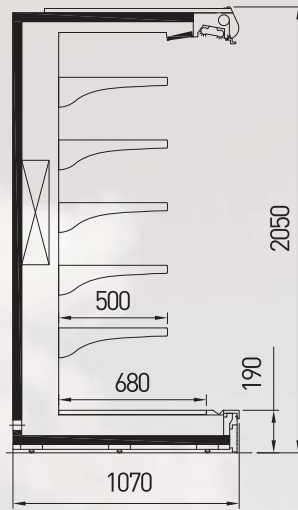

**DRACO G19 SL**

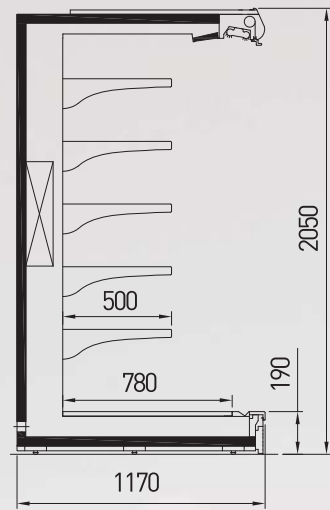

**DRACO D29 SL**

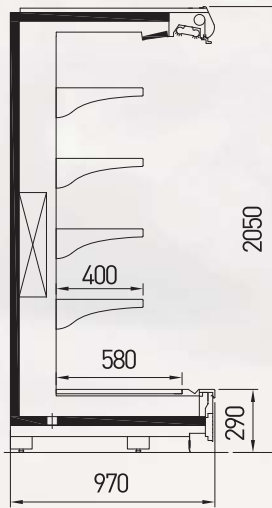

**DRACO M29 SL**

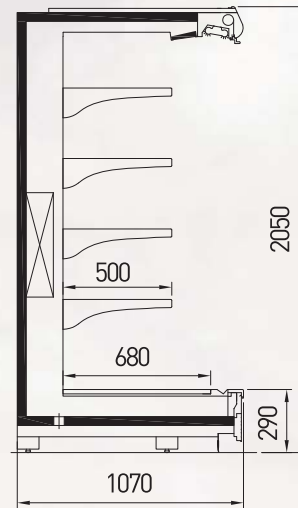

**DRACO G29 SL**

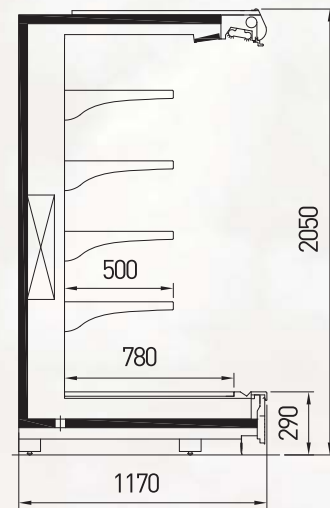

**DRACO D19 PE/SM**

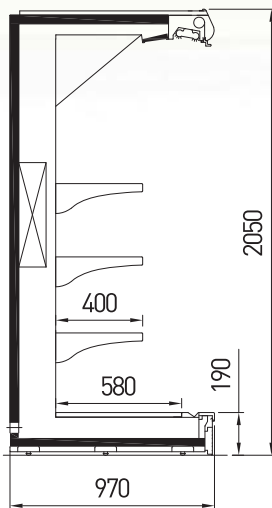

**DRACO M19 PE/SM**

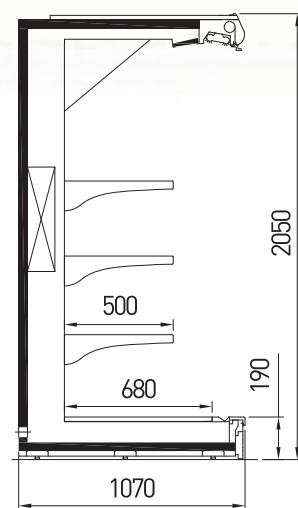

**DRACO G19 PE/SM**

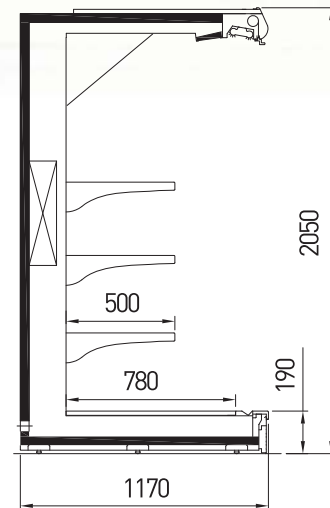

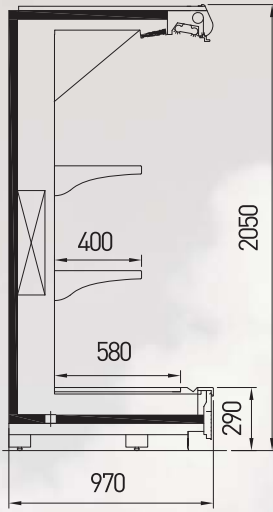
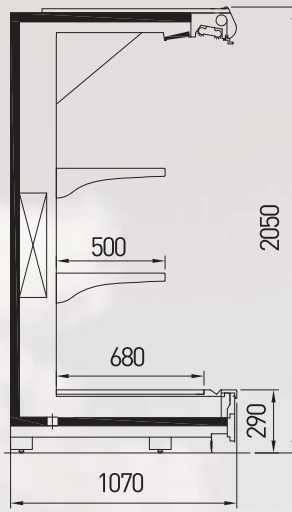
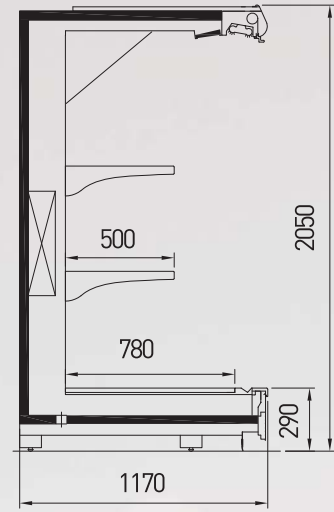
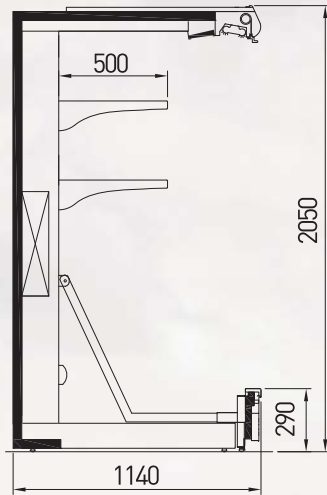
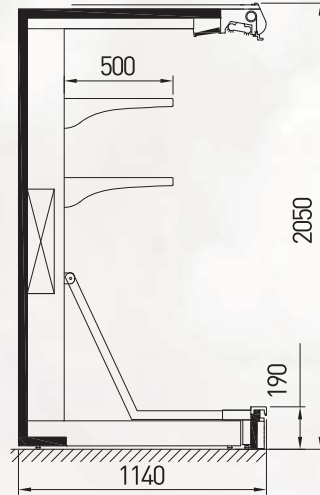
**DRACO D29 PE/SM****DRACO M29 PE/SM****DRACO G29 PE/SM****DRACO 29 LIFT****DRACO 19 LIFT****DRACO**

Length (mm)

	Temperature	1250	1875	2500	3750	2000 Head	2300 Head	2600 Head
D19 / D29 SL	M2 (-1 / +7°C)	◆	◆	◆	◆	◆	◆	◆
M19 / M29 SL	M2 (-1 / +7°C)	◆	◆	◆	◆		◆	◆
G19 / G29 SL	M2 (-1 / +7°C)	◆	◆	◆	◆			◆
D19 / D29 PE	M0 (-1 / +4°C); M1 (-1 / +5°C)	◆	◆	◆	◆	◆	◆	◆
M19 / M29 PE	M0 (-1 / +4°C); M1 (-1 / +5°C)	◆	◆	◆	◆		◆	◆
G19 / G29 PE	M0 (-1 / +4°C); M1 (-1 / +5°C)	◆	◆	◆	◆			◆
D19 / D29 SM	H1 (+1 / +10°C)	◆	◆	◆	◆	◆	◆	◆
M19 / M29 SM	H1 (+1 / +10°C)	◆	◆	◆	◆		◆	◆
G19 / G29 SM	H1 (+1 / +10°C)	◆	◆	◆	◆			◆
LIFT	M2 (-1 / +7°C)	◆	◆	◆	◆			◆
Side wall thickness (mm)		40						